

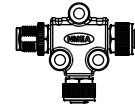

THIS DOCUMENT IS SUBJECT TO CHANGE WITHOUT NOTICE. IT IS CONFIDENTIAL AND A PROPERTY OF Amphenol LTW. DISCLOSURE TO THIRD PARTY HAS TO BE AUTHORIZED BY Amphenol LTW.

| | | | | |
|------|---------|------------|------|-------------|
| REV. | ECN NO. | DATE | SIGN | DESCRIPTION |
| CA | C230552 | 2023-05-12 | Ruru | ⚠️ CA XI |

| | | | |
|------------------------|--------------------------------|--|---|
| Pro | ① HPC-050505-FFM-TS001 | 3 Tee Adaptor 2Pcs |  |
| | ② HMCP-05BFFT-SL8001 ⚠️ B | Female Terminator 1Pcs |  |
| | ③ HMCP-05BMMT-SL8001 ⚠️ B | Male Terminator 1Pcs |  |
| | ④ P-555500-FFFM00-S001 | 4Tee Adaptor 2Pcs |  |
| | ⑧ P-555555-FFFFFM-S001 | 6Tee Adaptor 2Pcs |  |
| | ⑤ HPC-000505-OMF-CSA02 | 2 Ends With Cable 2M, 1Pcs |  |
| | ⑥ HPC-000505-OMF-CSA05 | 2 Ends With Cable 5M, 1Pcs |  |
| ⑦ HPC-000505-OMF-CSA10 | 2 Ends With Cable 10M, 1Pcs |  | |

Note:
 * 3 Tee adaptor: 2PCS
 * Female Terminator 1PCS
 * Male Terminator :1PCS
 * 4Tee adapter connector 2pcs
 * 6 Tee adapter connector 2pcs
 * 2 Ends Cable, cable length 2m,5m,10m各1PCS,
 * All connector put into the blister tray
 * 注意繞線尺寸需符合圖面要求, 否則會影響產品裝入彩盒。
 * 5pcs blister tray /Carton
 * Net weight: 7.1kg / Carton
 * Gross weight: 9.3Kg / Carton

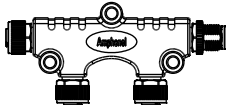
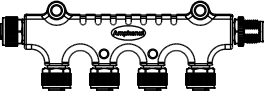
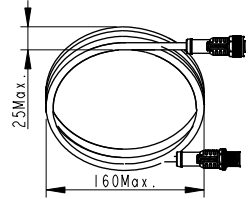
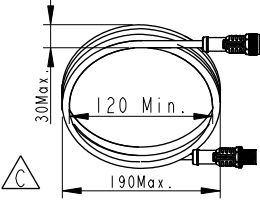
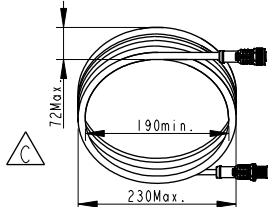
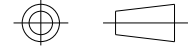
| | | | | | |
|-----------|---|-------|---|---------|-----------------|
| UNIT:mm |  | TITLE | NMEA2000 Starter Kit Plastic, Pro Type | | |
| TOLERANCE | | SCALE | Free | SIZE | A4 |
| | | REV. | CA | WC-REV. | A.1 |
| | | | | SHEET | 1 OF 2 |
| | | | | QC | Inspection item |

Amphenol LTW
 安費諾亮泰企業股份有限公司

| | | | | | |
|----------|-----------|-------------|-------------|------|------------|
| ITEM NO | HPC-P-001 | DRAWN BY | Frank Deng | DATE | 2018-12-12 |
| DWG NO | HPC-P-001 | CHECKED BY | Fisher Wang | DATE | 2018-12-12 |
| CUSTOMER | ALTW | APPROVED BY | Kevin Hu | DATE | 2018-12-12 |

THIS DOCUMENT IS SUBJECT TO CHANGE WITHOUT NOTICE. IT IS CONFIDENTIAL AND A PROPERTY OF Amphenol LTW. DISCLOSURE TO THIRD PARTY HAS TO BE AUTHORIZED BY Amphenol LTW.

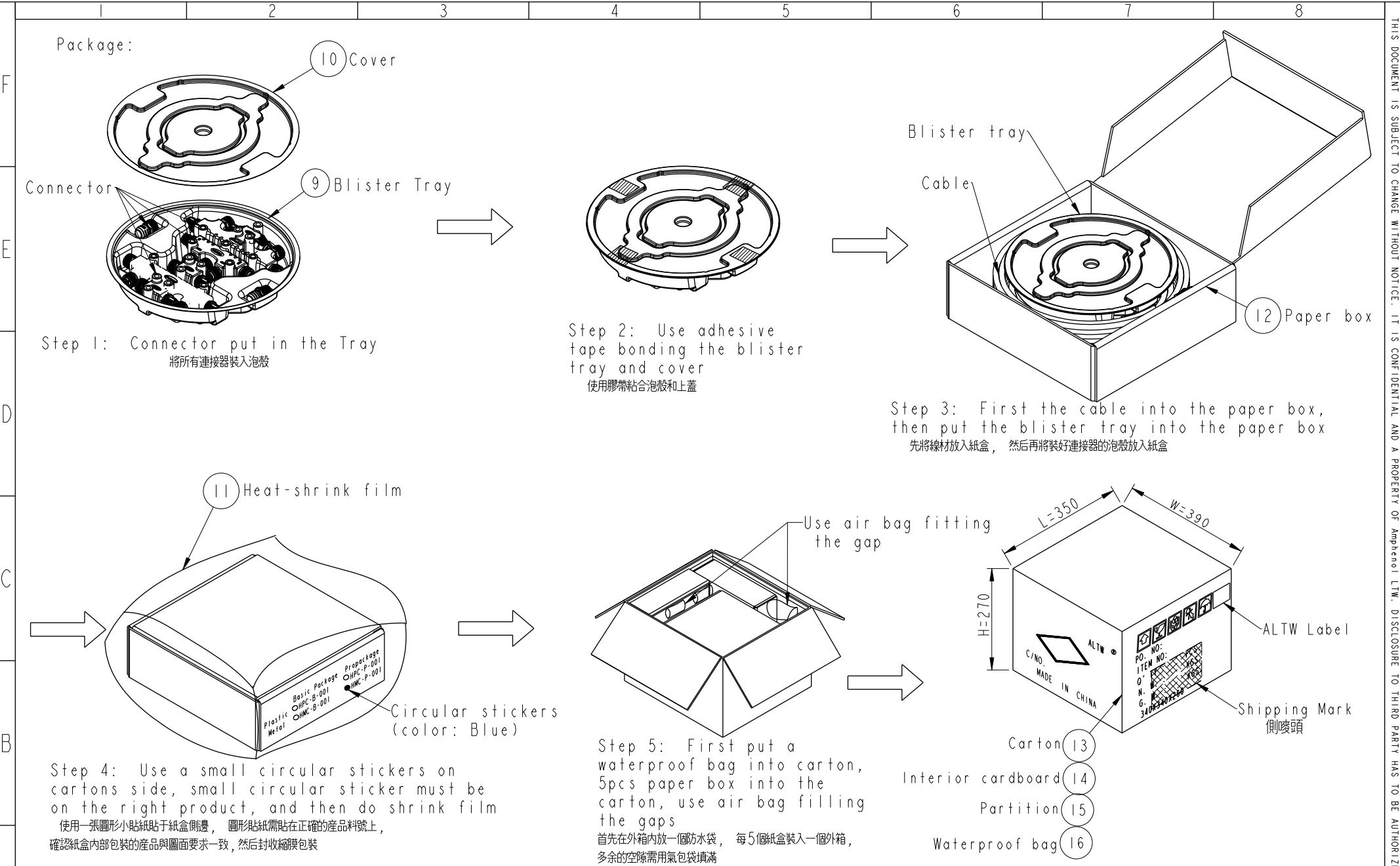

| | | | | | | | | | | | |
|----------|----|-----------|------|----------------------|-------------|-------------|------------|------|--------|------------|------|
| UNIT: mm | | TITLE | | NMEA2000 Starter Kit | | ITEM NO | DRAWN BY | DATE | | | |
| | | TOLERANCE | | Plastic, Pro Type | | | | | DWG NO | CHECKED BY | DATE |
| | | SCALE | SIZE | SHEET | OF | | | | | | |
| Free | A4 | 2 | 2 | HPC-P-001 | Fisher Wang | 2018-12-12 | | | | | |
| REV. | CA | WC-REV. | A.1 | ☉: Inspection item | ALTW | APPROVED BY | DATE | | | | |
| | | | | | | Kevin Hu | 2018-12-12 | | | | |

Amphenol LTW
安費諾亮泰企業股份有限公司