

THIS DOCUMENT IS SUBJECT TO CHANGE WITHOUT NOTICE. IT IS CONFIDENTIAL AND A PROPERTY OF AMPHENOL LTW. DISCLOSURE TO THIRD PARTY HAS TO BE AUTHORIZED BY AMPHENOL LTW.

REV.	ECN NO.	DATE	SIGN	DESCRIPTION
A		2022/09/30	Eagle	Rev.01 to Rev.A
B	C230296	2023/05/02	Eagle	$\triangle B$ x1

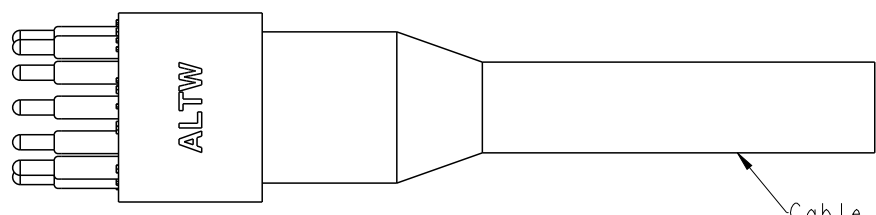

DT-HCM-XXBMM-RLA60

- G3: 3Pin
- G4: 4Pin
- 06: 6Pin
- 08: 8Pin
- 12: 12Pin

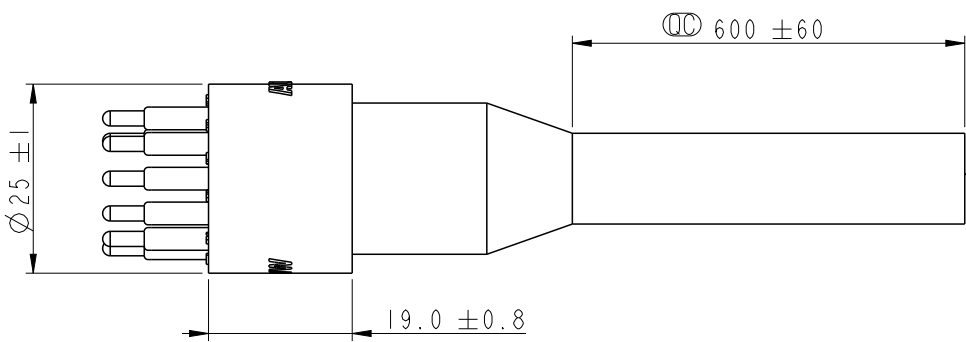
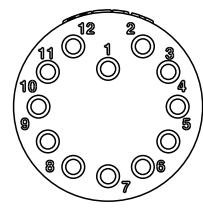

Simple Cut End

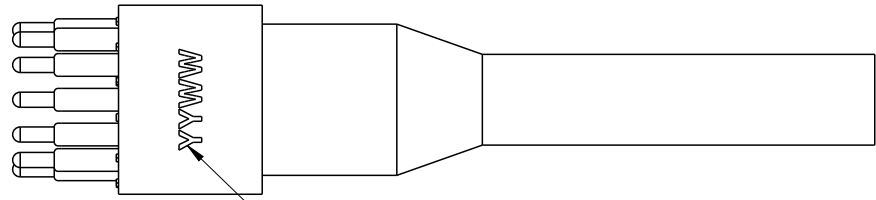

$\text{CC}$  Date Code(Laser mark)  
 YY(年)  
 WW(週)  
 上下左右置中

Note:

- \*  $\text{CC}$  Important Dimension.
- \* Waterproof Rate: Hadopelagic 7000M, Mated.
- \* Connector  
 Housing : Rubber, Black.  
 Pin : Copper Alloy, Gold Plated.
- \* Cable: 18 AWG for 3P/4P.  
 20 AWG for 6P/8P/12P.

	AWG	Cable OD(mm)	Wire OD(mm)
3P	18	9.7	2.71
4P	18	9.9	2.71
6P	20	9	1.79
8P	20	10	1.79
12P	20	11.2	1.79

UNIT: mm		
TOLERANCE ±0.5		

TITLE DT, HAD CIRCULAR MICRO CABLE W/O SR, M, M			
SCALE 1:1	SIZE A4	SHEET 1 OF 4	
REV. B	WC-REV. A.5	$\text{CC}$ : Inspection item	

**Amphenol LTW**  
 安費諾亮泰企業股份有限公司

ITEM NO	DRAWN BY Eagle	DATE 2022/09/30
DWG NO DT-HCM-XXBMM-RLA60	CHECKED BY Aric	DATE 2022/09/30
CUSTOMER ALTW	APPROVED BY Max	DATE 2022/09/30

THIS DOCUMENT IS SUBJECT TO CHANGE WITHOUT NOTICE. IT IS CONFIDENTIAL AND A PROPERTY OF Amphenol LTW. DISCLOSURE TO THIRD PARTY HAS TO BE AUTHORIZED BY Amphenol LTW.

For 3P/4P/6P/8P

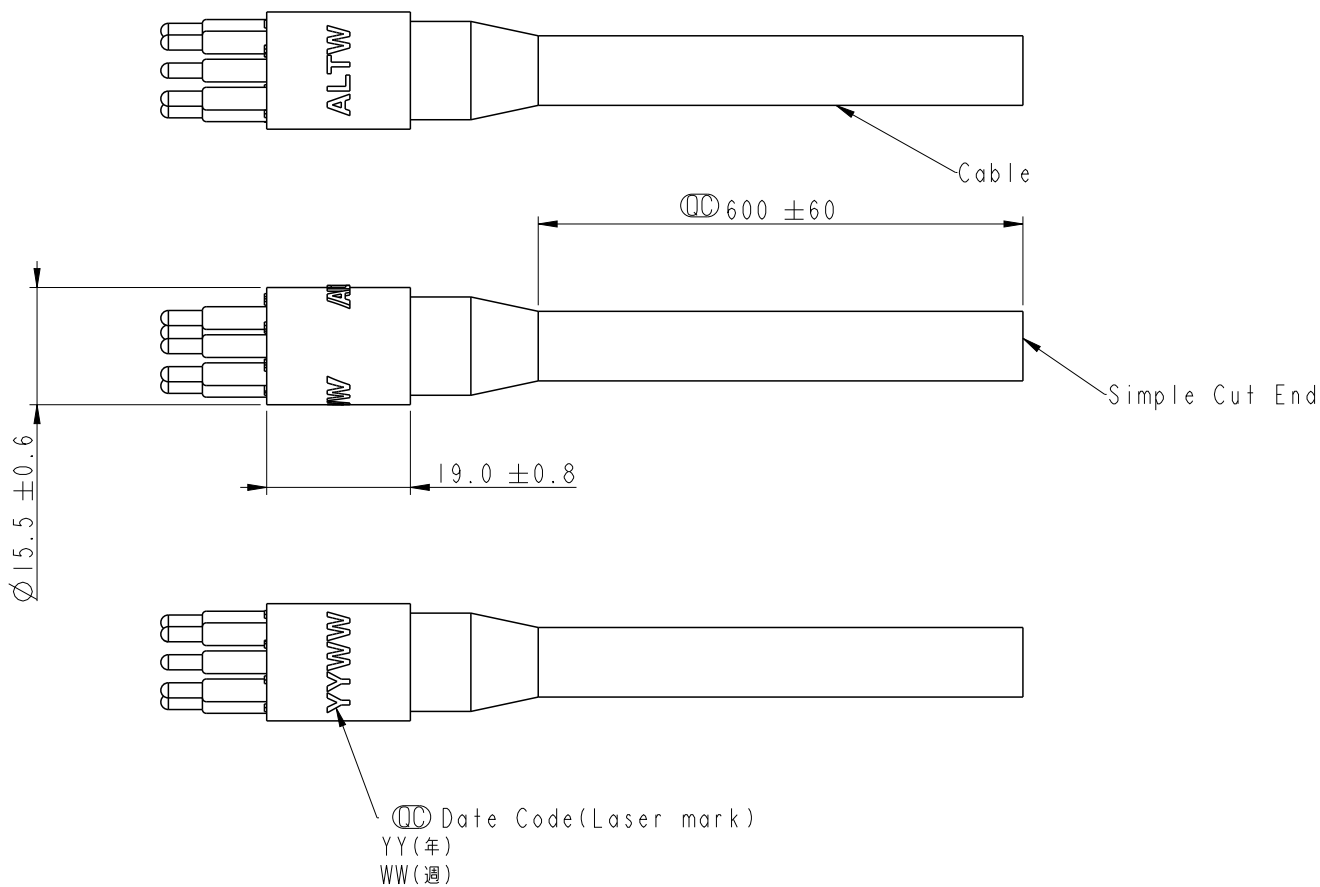
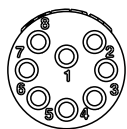

UNIT:mm  
TOLERANCE  
 $\pm 0.5$

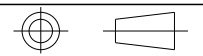

TITLE DT, HAD CIRCULAR MICRO CABLE W/O SR, M, M			
SCALE 1:1	SIZE A4	SHEET 2 OF 4	
REV. B	WC-REV.	☉: Inspection item	

**Amphenol LTW**  
安費諾亮泰企業股份有限公司

ITEM NO	DRAWN BY Eagle	DATE 2022/09/30
DWG NO DT-HCM-XXBMM-RLA60	CHECKED BY Aric	DATE 2022/09/30
CUSTOMER ALTW	APPROVED BY Max	DATE 2022/09/30

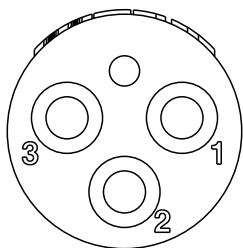

Pin Assignment(Front View)

- Pin Out (3P)  
 1 Black(黑) 18AWG  
 2 White(白) 18AWG  
 3 Red(紅) 18AWG

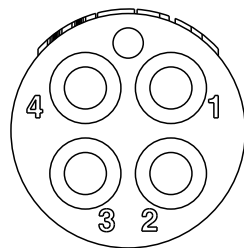

Pin Assignment(Front View)

- Pin Out (4P)  
 1 Black(黑) 18AWG  
 2 White(白) 18AWG  
 3 Red(紅) 18AWG  
 4 Green(綠) 18AWG

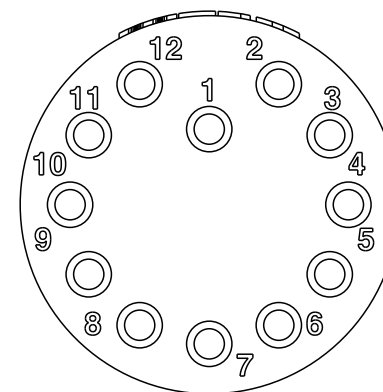

Pin Assignment(Front View)

- Pin Out (12P)  
 1 Black(黑) 20AWG  
 2 White(白) 20AWG  
 3 Red(紅) 20AWG  
 4 Green(綠) 20AWG  
 5 Orange(橙) 20AWG  
 6 Blue(藍) 20AWG  
 7 White/Black(白/黑) 20AWG  
 8 Red/Black(紅/黑) 20AWG  
 9 Green/Black(綠/黑) 20AWG  
 10 Orange/Black(橙/黑) 20AWG  
 11 Blue/Black(藍/黑) 20AWG  
 12 Black/White(黑/白) 20AWG

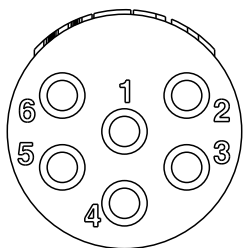

Pin Assignment(Front View)

- Pin Out (6P)  
 1 Black(黑) 20AWG  
 2 White(白) 20AWG  
 3 Red(紅) 20AWG  
 4 Green(綠) 20AWG  
 5 Orange(橙) 20AWG  
 6 Blue(藍) 20AWG

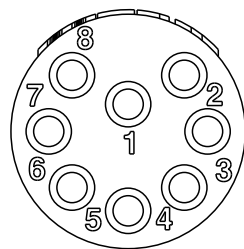

Pin Assignment(Front View)

- Pin Out (8P)  
 1 Black(黑) 20AWG  
 2 White(白) 20AWG  
 3 Red(紅) 20AWG  
 4 Green(綠) 20AWG  
 5 Orange(橙) 20AWG  
 6 Blue(藍) 20AWG  
 7 White/Black(白/黑) 20AWG  
 8 Red/Black(紅/黑) 20AWG

UNIT : mm  
 TOLERANCE  
 ±0.5

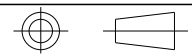

TITLE DT, HAD CIRCULAR MICRO CABLE W/O SR, M, M			
SCALE 1:1	SIZE A4	SHEET 3 OF 4	
REV. B	WC-REV.	QC: Inspection item	

**Amphenol LTW**  
 安費諾亮泰企業股份有限公司

ITEM NO	DRAWN BY Eagle	DATE 2022/09/30
DWG NO DT-HCM-XXBMM-RLA60	CHECKED BY Aric	DATE 2022/09/30
CUSTOMER ALTW	APPROVED BY Max	DATE 2022/09/30

THIS DOCUMENT IS SUBJECT TO CHANGE WITHOUT NOTICE. IT IS CONFIDENTIAL AND A PROPERTY OF Amphenol LTW. DISCLOSURE TO THIRD PARTY HAS TO BE AUTHORIZED BY Amphenol LTW.

1 2 3 4 5 6 7 8

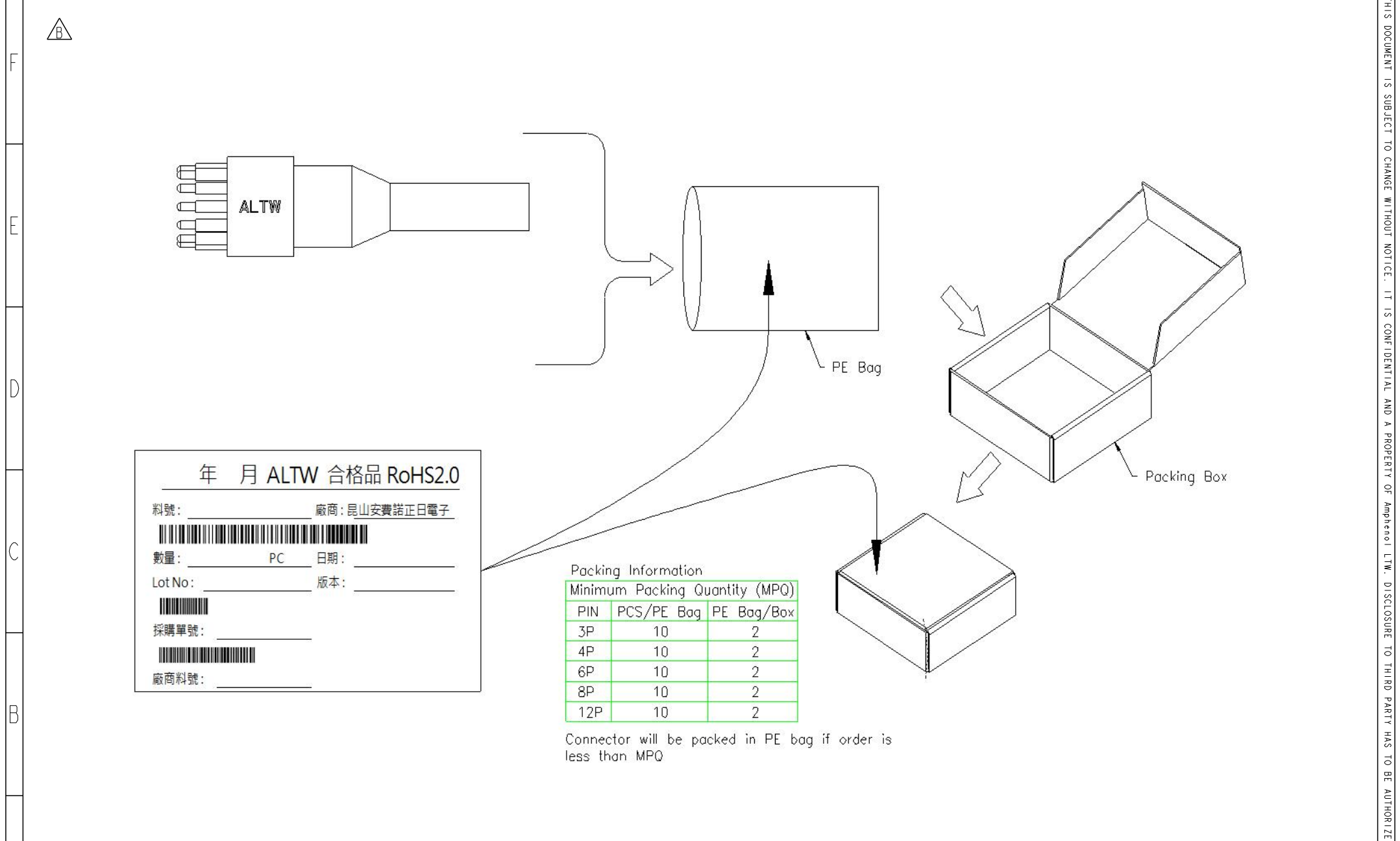

UNIT: mm TOLERANCE ±0.5	DT, HAD CIRCULAR MICRO CABLE W/O SR, M, M		<h1>Amphenol LTW</h1> <p>安費諾亮泰企業股份有限公司</p>	ITEM NO	DRAWN BY	DATE	
	SCALE 1:1	SIZE A4		SHEET 4 OF 4	DWG NO DT-HCM-XXBMM-RLA60	CHECKED BY Aric	DATE 2022/09/30
	REV. B	WC-REV.		☉: Inspection item	CUSTOMER ALTW	APPROVED BY Max	DATE 2022/09/30

1 2 3 4 5 6 7 8 W10814-03-001A2