

THIS DOCUMENT IS SUBJECT TO CHANGE WITHOUT NOTICE. IT IS CONFIDENTIAL AND A PROPERTY OF Amphenol LTW. DISCLOSURE TO THIRD PARTY HAS TO BE AUTHORIZED BY Amphenol LTW.

REV.	ECN NO.	DATE	SIGN	DESCRIPTION
B	C230296	2023/05/02	Eagle	△ B x I

For 12P

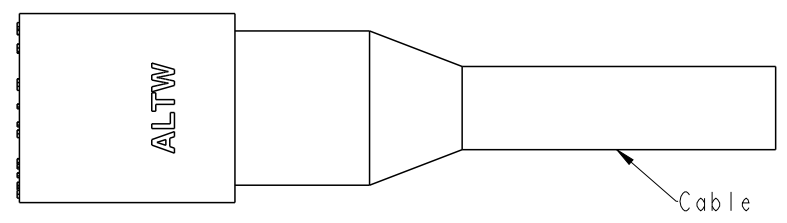

DT-ACM-XXBFF-RLA60

- G3: 3Pin
- G4: 4Pin
- 06: 6Pin
- 08: 8Pin
- 12: 12Pin

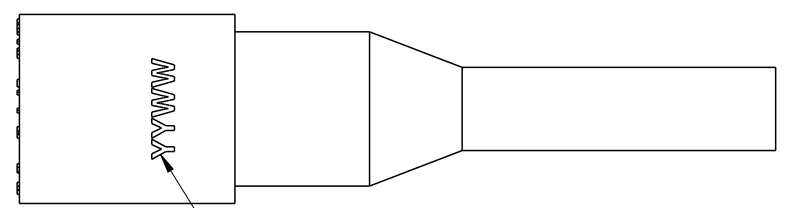
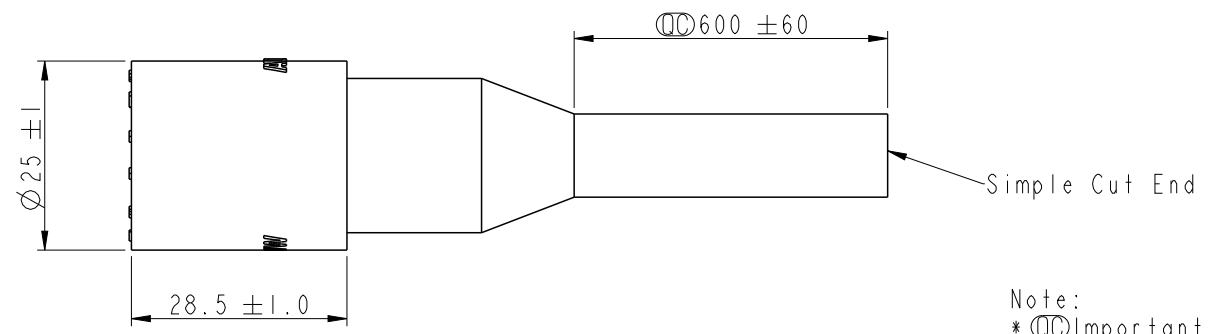
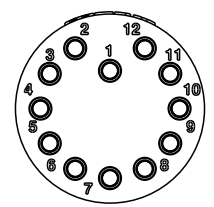

☉ Date Code(Laser mark)  
YY(年)  
WW(週)

Note:

- \* ☉ Important Dimension.
- \* Waterproof Rate: Abyssopelagic 4000M, Mated.
- \* Connector Housing : Rubber, Black.  
Pin : Copper Alloy, Gold Plated.
- \* Cable: 18 AWG for 3P/4P.  
20 AWG for 6P/8P/12P.

	AWG	Cable OD(mm)	Wire OD(mm)
3P	18	9.7	2.71
4P	18	9.9	2.71
6P	20	9	1.79
8P	20	10	1.79
12P	20	11.2	1.79

UNIT: mm		
TOLERANCE ±0.5		

TITLE DT, ABY CIRCULAR MICRO CABLE W/O SR, F, F			
SCALE 1:1	SIZE A4	SHEET 1 OF 4	
REV. B	WC-REV. A.5	☉: Inspection item	

**Amphenol LTW**  
安費諾亮泰企業股份有限公司

ITEM NO	DRAWN BY Eagle	DATE 2022/11/08
DWG NO DT-ACM-XXBFF-RLA60	CHECKED BY Aric	DATE 2022/11/08
CUSTOMER ALTW	APPROVED BY Max	DATE 2022/11/08

THIS DOCUMENT IS SUBJECT TO CHANGE WITHOUT NOTICE. IT IS CONFIDENTIAL AND A PROPERTY OF AMPHENOL LTW. DISCLOSURE TO THIRD PARTY HAS TO BE AUTHORIZED BY AMPHENOL LTW.

For 3P/4P/6P/8P

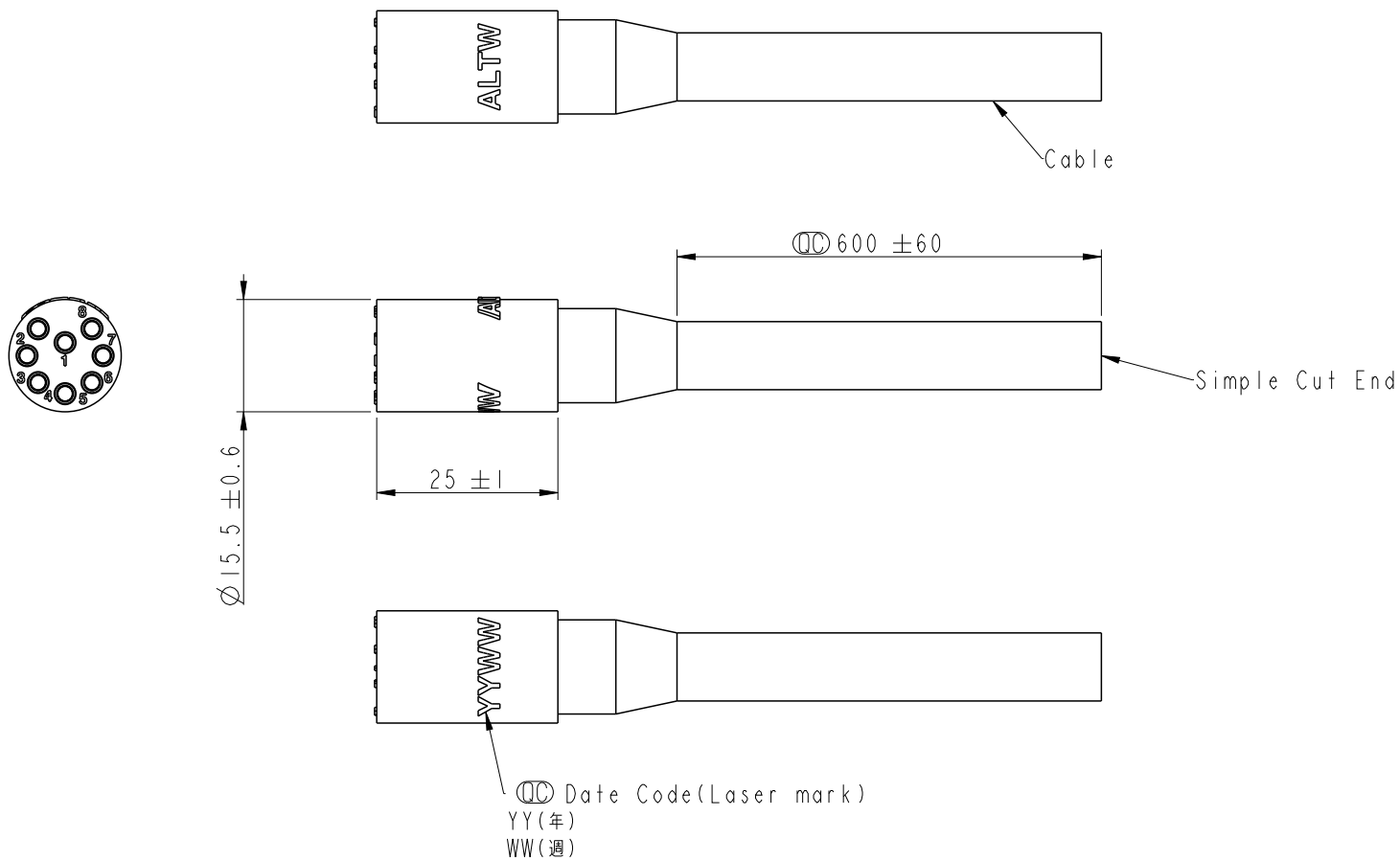

UNIT: mm  
TOLERANCE  
 $\pm 0.5$

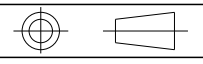

TITLE DT, ABY CIRCULAR MICRO CABLE W/O SR, F, F			
SCALE 1:1	SIZE A4	SHEET 2 OF 4	
REV. B	WC-REV.	$\text{CC}$ : Inspection item	

**Amphenol LTW**  
安費諾亮泰企業股份有限公司

ITEM NO	DRAWN BY Eagle	DATE 2022/11/08
DWG NO DT-ACM-XXBFF-RLA60	CHECKED BY Aric	DATE 2022/11/08
CUSTOMER ALTW	APPROVED BY Max	DATE 2022/11/08

THIS DOCUMENT IS SUBJECT TO CHANGE WITHOUT NOTICE. IT IS CONFIDENTIAL AND A PROPERTY OF Amphenol LTW. DISCLOSURE TO THIRD PARTY HAS TO BE AUTHORIZED BY Amphenol LTW.

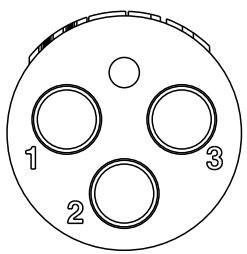

Pin Assignment(Front View)

- Pin Out (3P)  
 1 Black(黑) 18AWG  
 2 White(白) 18AWG  
 3 Red(紅) 18AWG

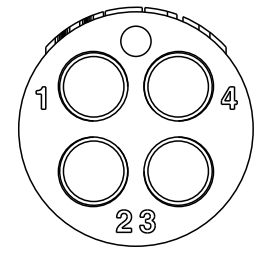

Pin Assignment(Front View)

- Pin Out (4P)  
 1 Black(黑) 18AWG  
 2 White(白) 18AWG  
 3 Red(紅) 18AWG  
 4 Green(綠) 18AWG

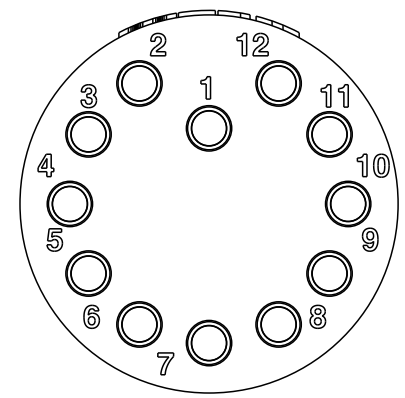

Pin Assignment(Front View)

- Pin Out (12P)  
 1 Black(黑) 20AWG  
 2 White(白) 20AWG  
 3 Red(紅) 20AWG  
 4 Green(綠) 20AWG  
 5 Orange(橙) 20AWG  
 6 Blue(藍) 20AWG  
 7 White/Black(白/黑) 20AWG  
 8 Red/Black(紅/黑) 20AWG  
 9 Green/Black(綠/黑) 20AWG  
 10 Orange/Black(橙/黑) 20AWG  
 11 Blue/Black(藍/黑) 20AWG  
 12 Black/White(黑/白) 20AWG

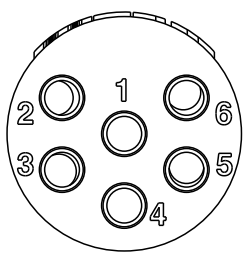

Pin Assignment(Front View)

- Pin Out (6P)  
 1 Black(黑) 20AWG  
 2 White(白) 20AWG  
 3 Red(紅) 20AWG  
 4 Green(綠) 20AWG  
 5 Orange(橙) 20AWG  
 6 Blue(藍) 20AWG

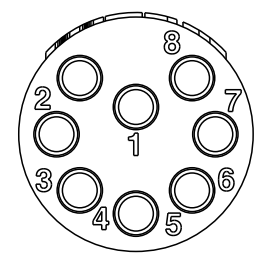

Pin Assignment(Front View)

- Pin Out (8P)  
 1 Black(黑) 20AWG  
 2 White(白) 20AWG  
 3 Red(紅) 20AWG  
 4 Green(綠) 20AWG  
 5 Orange(橙) 20AWG  
 6 Blue(藍) 20AWG  
 7 White/Black(白/黑) 20AWG  
 8 Red/Black(紅/黑) 20AWG

UNIT:mm

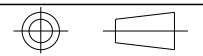

TITLE DT, ABY CIRCULAR MICRO CABLE W/O SR, F, F			
SCALE 1:1	SIZE A4	SHEET 3 OF 4	
REV. B	WC-REV.	QC: Inspection item	

**Amphenol LTW**  
 安費諾亮泰企業股份有限公司

ITEM NO	DRAWN BY Eagle	DATE 2022/11/08
DWG NO DT-ACM-XXBFF-RLA60	CHECKED BY Aric	DATE 2022/11/08
CUSTOMER ALTW	APPROVED BY Max	DATE 2022/11/08

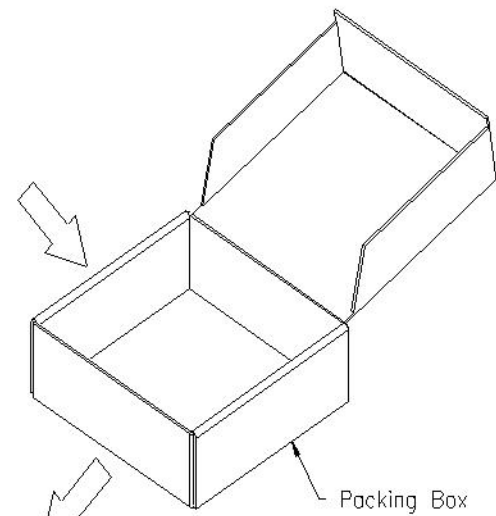
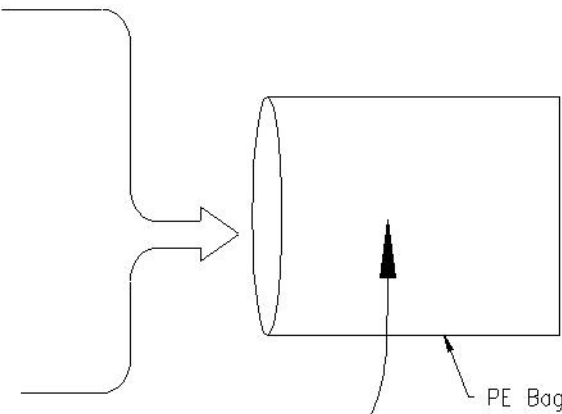
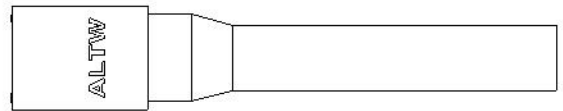

年 月 ALTW 合格品 RoHS2.0

料號: \_\_\_\_\_ 廠商: 昆山安費諾正日電子



數量: \_\_\_\_\_ PC 日期: \_\_\_\_\_

Lot No: \_\_\_\_\_ 版本: \_\_\_\_\_



採購單號: \_\_\_\_\_



廠商料號: \_\_\_\_\_

Packing Information

Minimum Packing Quantity (MPQ)		
PIN	PCS/PE Bag	PE Bag/Box
3P	10	2
4P	10	2
6P	10	2
8P	10	2
12P	10	2

Connector will be packed in PE bag if order is less than MPQ

UNIT: mm

TOLERANCE  
±0.5

TITLE  
DT, ABY CIRCULAR MICRO  
CABLE W/O SR, F, F

SCALE 1:1	SIZE A4	SHEET 4	OF 4
REV. B	WC-REV.	QC: Inspection item	

**Amphenol LTW**  
安費諾亮泰企業股份有限公司

ITEM NO	DRAWN BY Eagle	DATE 2022/11/08
DWG NO DT-ACM-XXBFF-RLA60	CHECKED BY Aric	DATE 2022/11/08
CUSTOMER ALTW	APPROVED BY Max	DATE 2022/11/08