

THIS DOCUMENT IS SUBJECT TO CHANGE WITHOUT NOTICE. IT IS CONFIDENTIAL AND A PROPERTY OF Amphenol LTW. DISCLOSURE TO THIRD PARTY HAS TO BE AUTHORIZED BY Amphenol LTW.

REV.	ECN NO.	DATE	SIGN	DESCRIPTION
B	C230419	2023/03/29	Vicky	△B X5

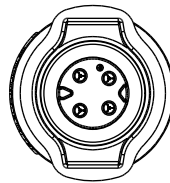
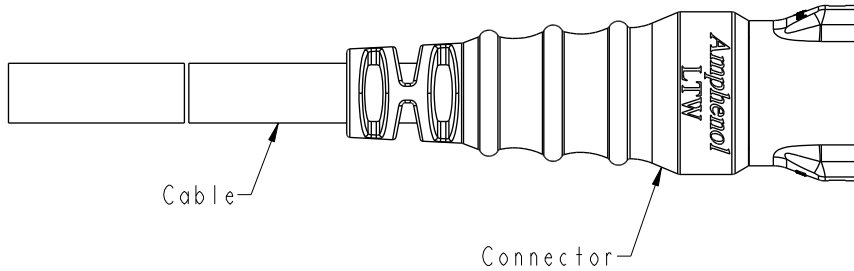
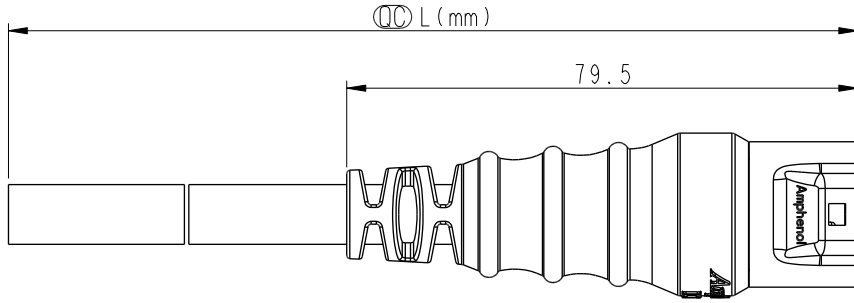

Conn.

- △B Note:
- * RoHS Compliant
 - * Ⓞ Important dimension
 - * Waterproof rate: IP68, mated 1m/24h
 - * Connector
 - Housing: Thermoplastic, Black
 - Pin: Copper alloy, Gold plated
 - O-Ring: Rubber, Gray
 - Outer mold: Thermoplastic, Black
 - * Cable: SJTW, PVC Jacket, Black
 - * Cable length tolerance: 1M: +50/-0 mm

1M < L ≤ 3M:	+100/-0 mm
3M < L ≤ 5M:	+150/-0 mm
5M < L ≤ 10M:	±100 mm
10M < L ≤ 20M:	±200 mm
20M < L ≤ 30M:	±300 mm
30M < L ≤ 99M:	±500 mm

UNIT: mm			TITLE RBL, C-10A, CABLE W/SR F, M, MOLDING, RBL	△B
TOLERANCE ±0.5mm	SCALE 1:1	SIZE A4	SHEET 1 OF 2	REV. B
	WC-REV. A.5	Ⓞ: Inspection item		

Amphenol LTW		ITEM NO	DRAWN BY	DATE
安費諾亮泰企業股份有限公司		DWG NO CB-XXAFMM-RL8EXX	Peng	2019-03-22
		CUSTOMER ALTW	MAFEI	2019-03-22
			JERRY	2019-03-22

THIS DOCUMENT IS SUBJECT TO CHANGE WITHOUT NOTICE. IT IS CONFIDENTIAL AND A PROPERTY OF Amphenol LTW. DISCLOSURE TO THIRD PARTY HAS TO BE AUTHORIZED BY Amphenol LTW.

	4P	9.3	16	CB-04AFMM-RL8EXX
	3P	8.6		CB-03AFMM-RL8EXX
	2P	8.2		CB-02AFMM-RL8EXX
△B	Contacts	Cable OD	AWG	Item No.

△B CB-XXAFMM-RL8EXX

XX: No. Of Pin

XX: 01~99Meters
 01: 01Meter
 02: 02Meters
 :
 99: 99Meters

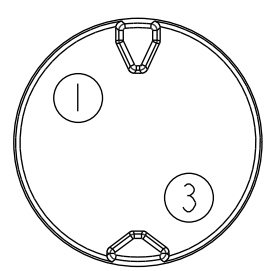
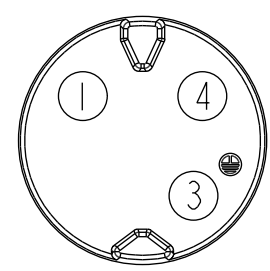
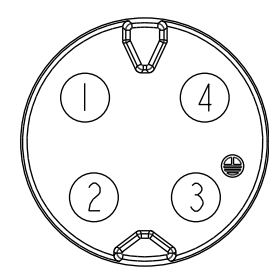
C	Pin Out	4 -- 3 White 白 2 -- 1 Black 黑	4 Green 綠 3 White 白 2 -- 1 Black 黑	4 Green 綠 3 White 白 2 Red 紅 1 Black 黑
	Conn.			

Pin Assignments Front View

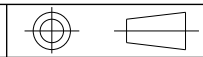
A	UNIT:mm		TITLE	RBL, C-10A, CABLE W/SR F, M, MOLDING, RBL	△B					
	TOLERANCE	±0.5mm	SCALE	1:1	SIZE	A4	SHEET	2	OF	2
			REV.	B	WC-REV.	A.5	Ⓞ: Inspection item			

Amphenol LTW
 安費諾亮泰企業股份有限公司

ITEM NO	DRAWN BY	DATE
DWG NO	CHECKED BY	DATE
CUSTOMER	APPROVED BY	DATE